

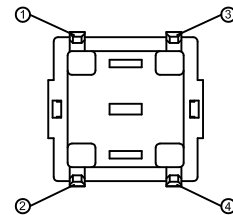

宏聚电子五金制品有限公司

HONGJU ELECTRONIC & METAL PRODUCTS CO.,LTD

TS6

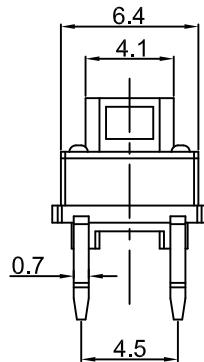
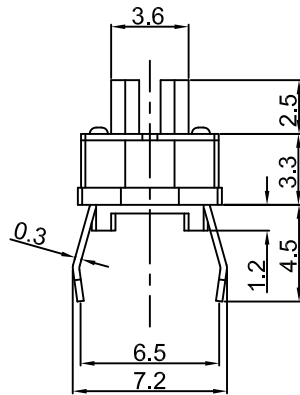
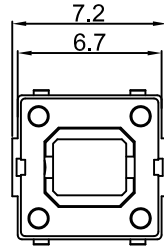
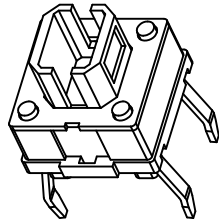

Specifications	
Circuit	:SPST
Current rating	:50mA
Voltage rating	:12VDC
Dielectric withstanding voltage	:250VAC for 1 minute
Contact resistance	:100mΩ Max. (Initial)
Insulation resistance	:100MΩ Min.
Operating force	:250±50gf :180±50gf
Total travel	:0.25mm±0.1mm
Operating life	:100,000 cycles Min
Solder specifications	:260° C for 5 seconds
Function	:Momentary
Operating temperature	:+10° C ~ +60° C

P.C.B. LAYOUT

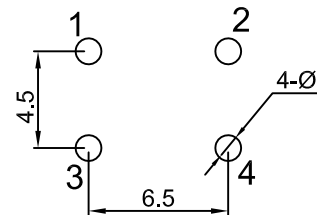

CIRCUIT

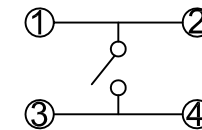

**MATERIAL:**

Base Frame:Nylon46,UL rated:94V-2 Min. ;  
 Top Cover:PET,UL rated:94V-2 Min. ;  
 Actuator: Nylon66, UL rated:94V-2 Min. ;  
 Terminal:Brass with Silver-plate.

				公差 TOLEANCES	.X± 0.3	.XX± 0.15	角度 ANGLE ± 1°	单位 DIMENSION UNIT	mm.
				版本 VERSION	A1	比例尺 SCALE	NONE	品名 TITLE	图号 DRAWING NO
				核准		核对	Z.H.B.	日期 DATE	2020.07.10
A1	重新整理发行	2014.07.10	N/A	核 准		核 对		绘 图	
版本 VER.	变更说明 CHANGE DESCRIPTION	日期 DATE	ECN NO.	APPROVED BY		CHECKED BY		DRAWN BY	
								TS6-00-00-N	TS6-00-00-N_A1